



**duplo**



**10928**  
LEGO.com/DUPL0





1

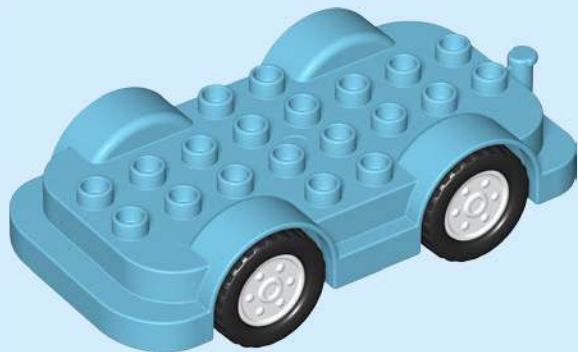

2



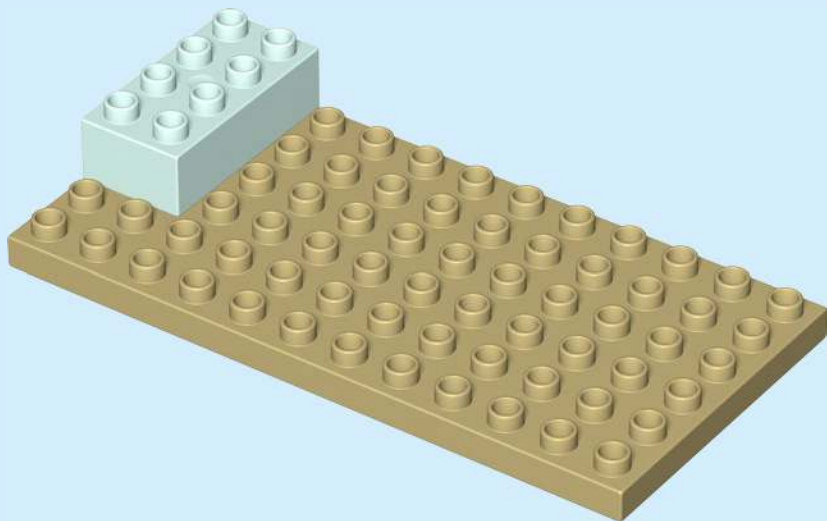
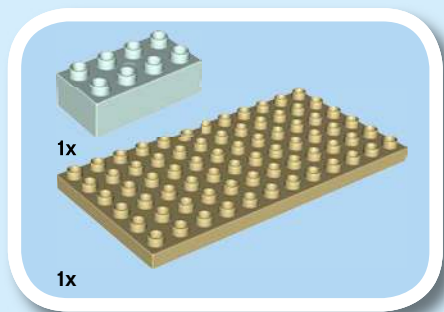

1

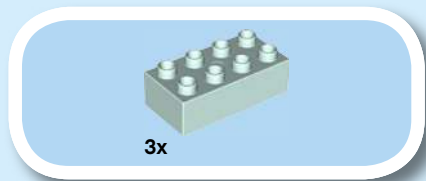

2

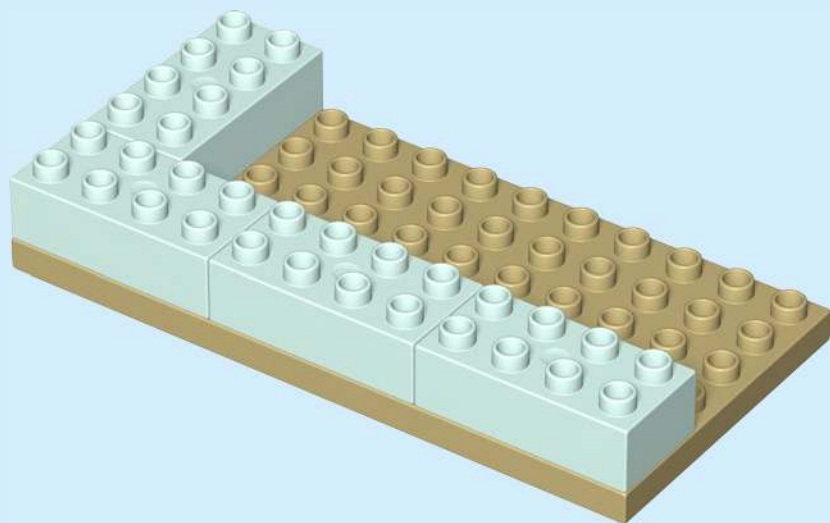

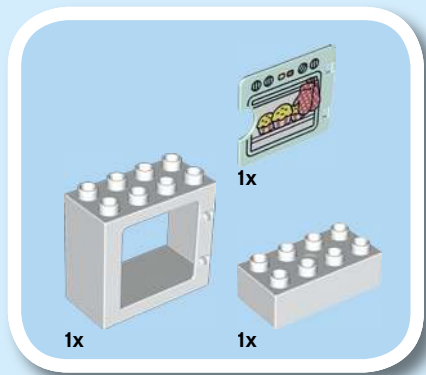

**3**

**1**

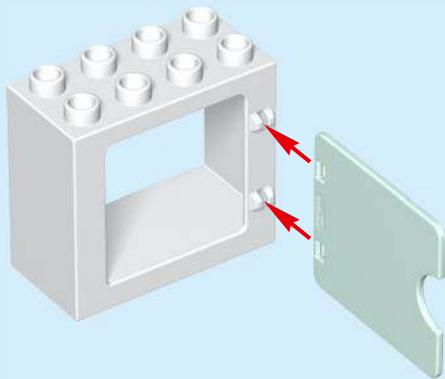

**2**

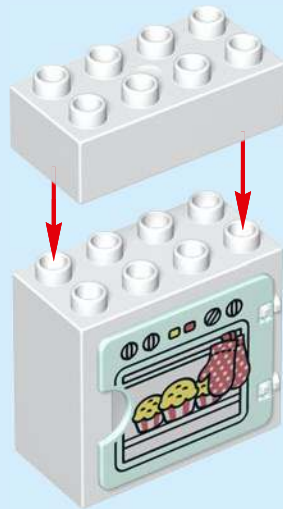

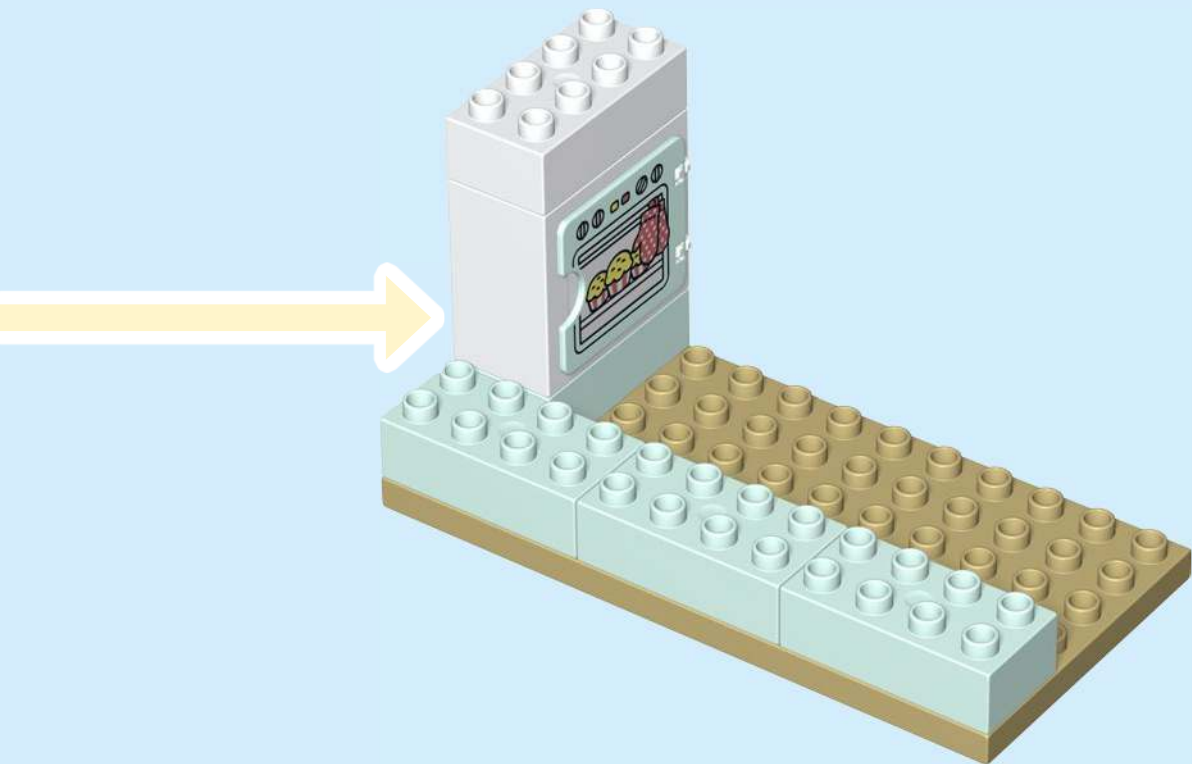

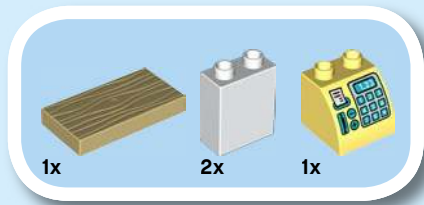

4

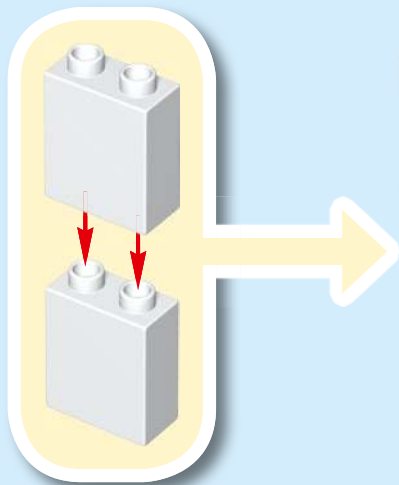



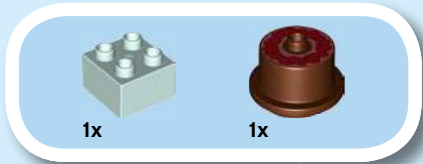

5

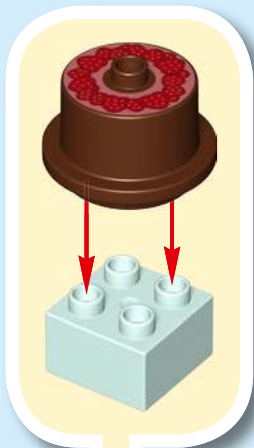

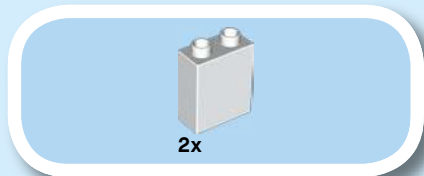

6

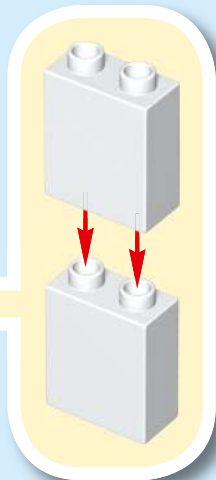

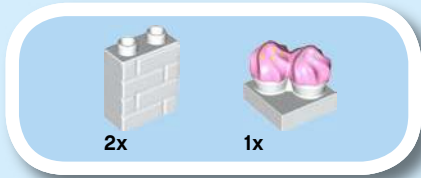

7

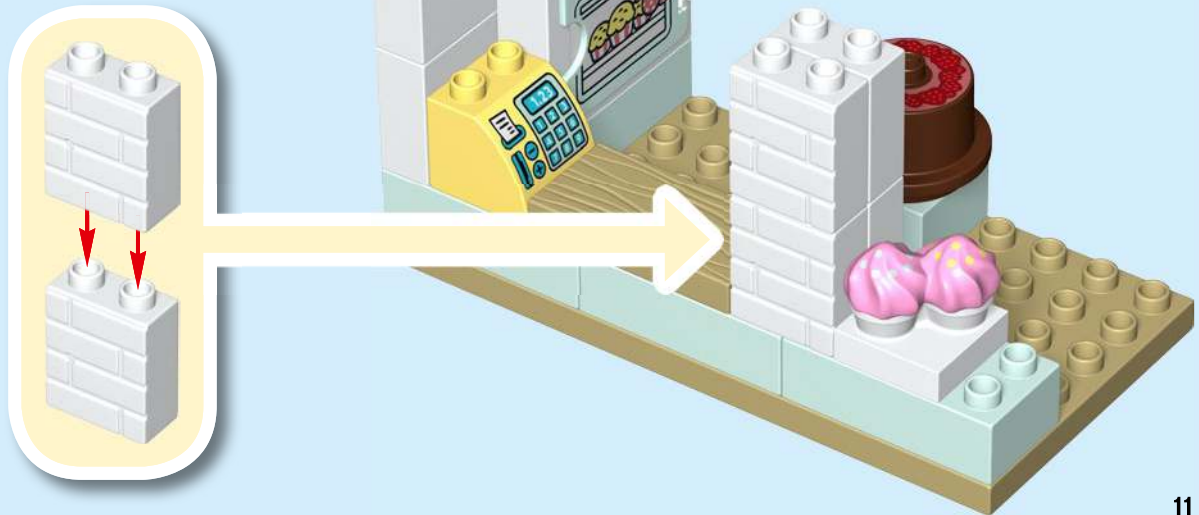

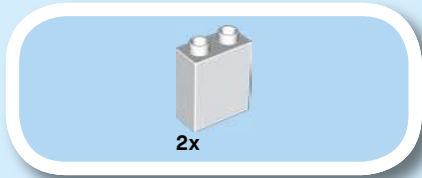

8

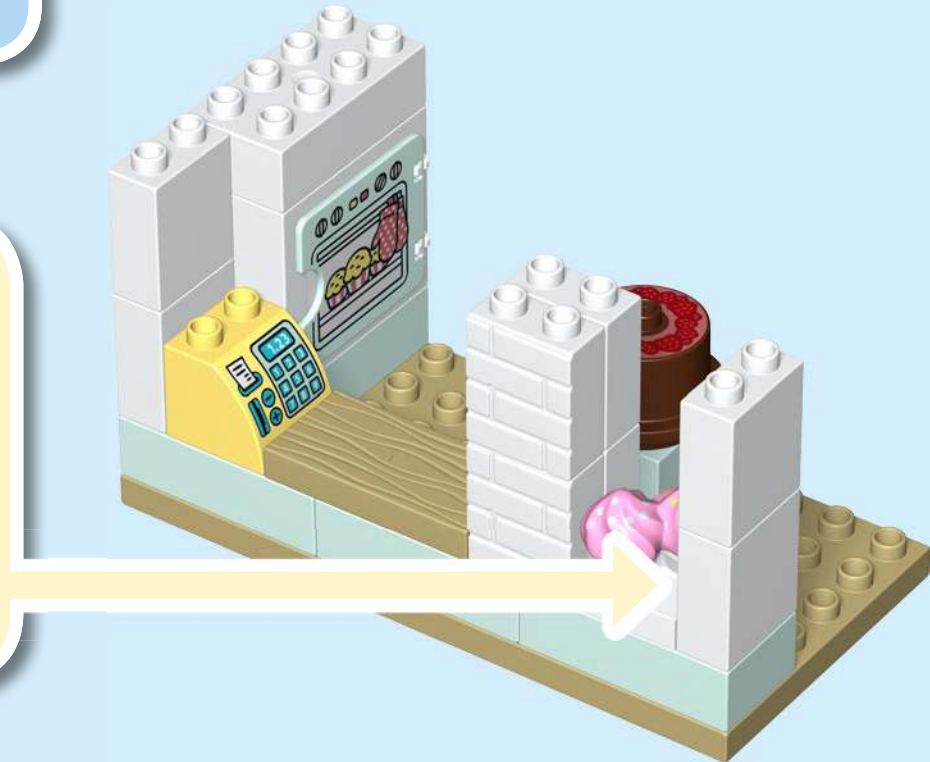
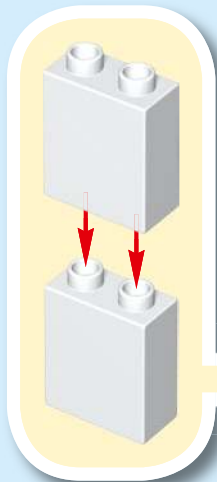

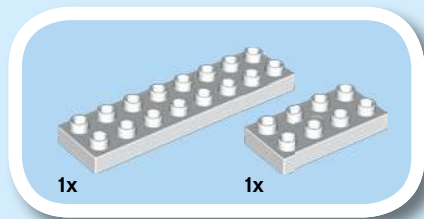

9



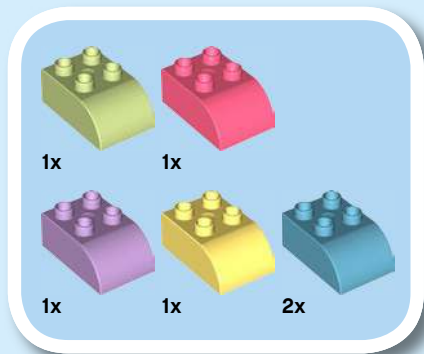

10





11



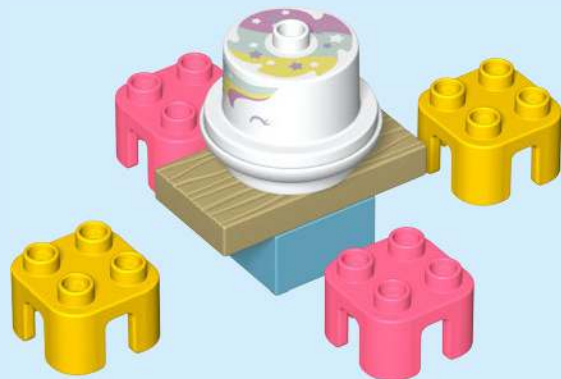
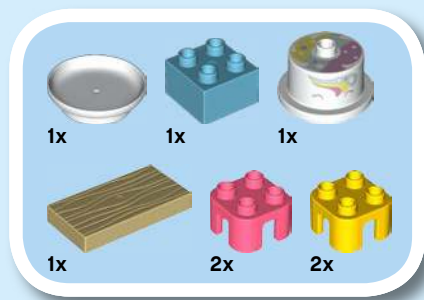
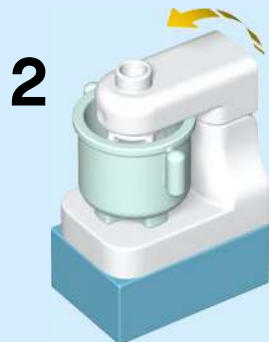
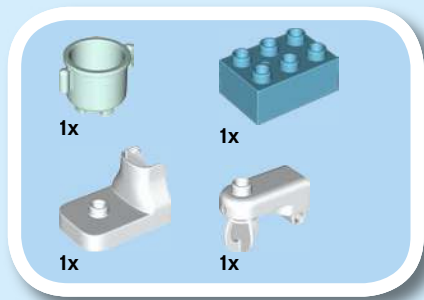







# duplo

Age

# 1 1/2

10915  
Age 1 1/2+



EXTRA  
IDEAS  
INCLUDED



10913  
Age 1 1/2+

Extra Ideas Included  
Mit zusätzlichen Bauiden  
Idées supplémentaires incluses  
Idee aggiuntive incluse  
Incluye ideas extra  
Inclui Ideias Extra  
Extra ötletek a csomagban  
lekjautas papíldu idejas  
内含更多创意



# 2+



10929  
Age 2+



# A WORLD OF LEGO® DUPLO®

EINE LEGO® DUPLO® WELT / LE MONDE DE LEGO®  
DUPLO® / UN MONDO DI LEGO® DUPLO® / UN MUNDO  
DE LEGO® DUPLO® / UM MUNDO DE LEGO® DUPLO® /  
A LEGO® DUPLO® VILÁGA / LEGO® DUPLO® PASAULE  
丰富多彩的乐高®得宝®世界



The availability of apps is subject to the local strategies of the LEGO Group.

Die Verfügbarkeit der Apps unterliegt der Strategie der LEGO Gruppe für das jeweilige Land.

La disponibilité des applications est soumise aux stratégies locales du groupe LEGO.

La disponibilità dell'app è soggetta alle strategie locali del LEGO Group.

La disponibilidad de las apps está sujeta a las estrategias regionales de The LEGO Group.

A disponibilidade das apps está sujeita às estratégias locais do Grupo LEGO.

Az alkalmazások elérhetőségét a LEGO Csoport helyi stratégiája határozza meg.

Lietotņu pieejamība ir atkarīga no LEGO Group vietējās stratēģijas.

相关应用是否在当地发行取决于乐高集团在当地的市场策略



Customer Service  
Kundenservice  
Service Consommateurs  
Servicio Al Consumidor

LEGO.com/service or dial

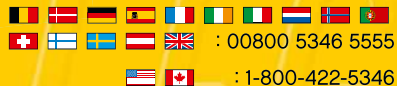
 : 00800 5346 5555  
: 1-800-422-5346



Go to [www.LEGO.com/productfeedback](http://www.LEGO.com/productfeedback)  
and give us your short  
**win**  
**feedback** about this  
LEGO® DUPLO® set for a chance to win  
a cool LEGO prize

Terms & Conditions apply

## LEGO.com/productfeedback

### GEWINNE

Erzähle uns auf  
[www.LEGO.com/productfeedback](http://www.LEGO.com/productfeedback)

etwas über die Erfahrungen, die du  
mit diesem LEGO® Set gemacht hast,  
und sichere dir die Chance auf einen  
coolen LEGO Preis!

Es gelten die Teilnahmebedingungen

### GAGNE

Rends-toi sur  
[www.LEGO.com/productfeedback](http://www.LEGO.com/productfeedback)

et donne-nous quelques commen-  
taires sur ce produit LEGO® pour  
avoir une chance de gagner un  
prix LEGO !

Voir Conditions Générales

### GANAN

Visita  
[www.LEGO.com/productfeedback](http://www.LEGO.com/productfeedback)

y envíanos tu opinión acerca de este  
set LEGO®. ¡Participarás en el sorteo  
de un premio LEGO!

Términos y Condiciones aplicables

### 获取奖品

登录  
[www.LEGO.com/productfeedback](http://www.LEGO.com/productfeedback)

给出关于此乐高®套装的简短反  
馈，就有机会获得炫酷乐高奖品

《条款及条件》适用