

PRIME Z390M-PLUS

ASUS®

Motherboard

E15010
Second Edition
November 2018

Copyright © 2018 ASUSTeK COMPUTER INC. All Rights Reserved.

No part of this manual, including the products and software described in it, may be reproduced, transmitted, transcribed, stored in a retrieval system, or translated into any language in any form or by any means, except documentation kept by the purchaser for backup purposes, without the express written permission of ASUSTeK COMPUTER INC. ("ASUS").

Product warranty or service will not be extended if: (1) the product is repaired, modified or altered, unless such repair, modification of alteration is authorized in writing by ASUS; or (2) the serial number of the product is defaced or missing.

ASUS PROVIDES THIS MANUAL "AS IS" WITHOUT WARRANTY OF ANY KIND, EITHER EXPRESS OR IMPLIED, INCLUDING BUT NOT LIMITED TO THE IMPLIED WARRANTIES OR CONDITIONS OF MERCHANTABILITY OR FITNESS FOR A PARTICULAR PURPOSE. IN NO EVENT SHALL ASUS, ITS DIRECTORS, OFFICERS, EMPLOYEES OR AGENTS BE LIABLE FOR ANY INDIRECT, SPECIAL, INCIDENTAL, OR CONSEQUENTIAL DAMAGES (INCLUDING DAMAGES FOR LOSS OF PROFITS, LOSS OF BUSINESS, LOSS OF USE OR DATA, INTERRUPTION OF BUSINESS AND THE LIKE), EVEN IF ASUS HAS BEEN ADVISED OF THE POSSIBILITY OF SUCH DAMAGES ARISING FROM ANY DEFECT OR ERROR IN THIS MANUAL OR PRODUCT.

SPECIFICATIONS AND INFORMATION CONTAINED IN THIS MANUAL ARE FURNISHED FOR INFORMATIONAL USE ONLY, AND ARE SUBJECT TO CHANGE AT ANY TIME WITHOUT NOTICE, AND SHOULD NOT BE CONSTRUED AS A COMMITMENT BY ASUS. ASUS ASSUMES NO RESPONSIBILITY OR LIABILITY FOR ANY ERRORS OR INACCURACIES THAT MAY APPEAR IN THIS MANUAL, INCLUDING THE PRODUCTS AND SOFTWARE DESCRIBED IN IT.

Products and corporate names appearing in this manual may or may not be registered trademarks or copyrights of their respective companies, and are used only for identification or explanation and to the owners' benefit, without intent to infringe.

Offer to Provide Source Code of Certain Software

This product contains copyrighted software that is licensed under the General Public License ("GPL"), under the Lesser General Public License Version ("LGPL") and/or other Free Open Source Software Licenses. Such software in this product is distributed without any warranty to the extent permitted by the applicable law. Copies of these licenses are included in this product.

Where the applicable license entitles you to the source code of such software and/or other additional data, you may obtain it for a period of three years after our last shipment of the product, either

(1) for free by downloading it from <https://www.asus.com/support/>

or

(2) for the cost of reproduction and shipment, which is dependent on the preferred carrier and the location where you want to have it shipped to, by sending a request to:

ASUSTeK Computer Inc.
Legal Compliance Dept.
15 Li Te Rd.,
Beitou, Taipei 112
Taiwan

In your request please provide the name, model number and version, as stated in the About Box of the product for which you wish to obtain the corresponding source code and your contact details so that we can coordinate the terms and cost of shipment with you.

The source code will be distributed WITHOUT ANY WARRANTY and licensed under the same license as the corresponding binary/object code.

This offer is valid to anyone in receipt of this information.

ASUSTeK is eager to duly provide complete source code as required under various Free Open Source Software licenses. If however you encounter any problems in obtaining the full corresponding source code we would be much obliged if you give us a notification to the email address gpl@asus.com, stating the product and describing the problem (please DO NOT send large attachments such as source code archives, etc. to this email address).

Contents

Safety information.....	iv
About this guide.....	iv
Package contents.....	vi
PRIME Z390M-PLUS specifications summary.....	vi
Chapter 1: Product Introduction	
1.1 Before you proceed	1-1
1.2 Motherboard overview.....	1-1
1.3 Central Processing Unit (CPU)	1-10
1.4 System memory	1-11
Chapter 2: BIOS Information	
2.1 Managing and updating your BIOS	2-1
2.2 BIOS setup program	2-6
2.3 Exit menu	2-11

Safety information

Electrical safety

- To prevent electrical shock hazard, disconnect the power cable from the electrical outlet before relocating the system.
- When adding or removing devices to or from the system, ensure that the power cables for the devices are unplugged before the signal cables are connected. If possible, disconnect all power cables from the existing system before you add a device.
- Before connecting or removing signal cables from the motherboard, ensure that all power cables are unplugged.
- Seek professional assistance before using an adapter or extension cord. These devices could interrupt the grounding circuit.
- Ensure that your power supply is set to the correct voltage in your area. If you are not sure about the voltage of the electrical outlet you are using, contact your local power company.
- If the power supply is broken, do not try to fix it by yourself. Contact a qualified service technician or your retailer.

Operation safety

- Before installing the motherboard and adding devices on it, carefully read all the manuals that came with the package.
- Before using the product, ensure all cables are correctly connected and the power cables are not damaged. If you detect any damage, contact your dealer immediately.
- To avoid short circuits, keep paper clips, screws, and staples away from connectors, slots, sockets and circuitry.
- Avoid dust, humidity, and temperature extremes. Do not place the product in any area where it may become wet.
- Place the product on a stable surface.
- If you encounter technical problems with the product, contact a qualified service technician or your retailer.

About this guide

This user guide contains the information you need when installing and configuring the motherboard.

How this guide is organized

This guide contains the following parts:

- **Chapter 1: Product Introduction**
This chapter describes the features of the motherboard and the new technology it supports. It includes descriptions of the switches, jumpers, and connectors on the motherboard.
- **Chapter 2: BIOS Information**
This chapter discusses changing system settings through the BIOS Setup menus.

Where to find more information

Refer to the following sources for additional information and for product and software updates.

1. ASUS website

The ASUS website (www.asus.com) provides updated information on ASUS hardware and software products.

2. Optional documentation

Your product package may include optional documentation, such as warranty flyers, that may have been added by your dealer. These documents are not part of the standard package.

Conventions used in this guide

To ensure that you perform certain tasks properly, take note of the following symbols used throughout this manual.



DANGER/WARNING: Information to prevent injury to yourself when trying to complete a task.



CAUTION: Information to prevent damage to the components when trying to complete a task.



IMPORTANT: Instructions that you **MUST** follow to complete a task.



NOTE: Tips and additional information to help you complete a task.

Typography

Bold text

Indicates a menu or an item to select.

Italics

Used to emphasize a word or a phrase.

<Key>

Keys enclosed in the less-than and greater-than sign means that you must press the enclosed key.

Example: <Enter> means that you must press the Enter or Return key.

<Key1> + <Key2> + <Key3>

If you must press two or more keys simultaneously, the key names are linked with a plus sign (+).

Package contents

Check your motherboard package for the following items.

Motherboard	1 x ASUS PRIME Z390M-PLUS motherboard
Cables	2 x SATA 6.0 Gb/s cables
Accessories	1 x I/O Shield 1 x M.2 Screw Package
Application DVD	1 x Support DVD
Documentation	1 x User manual



If any of the above items is damaged or missing, contact your retailer.

PRIME Z390M-PLUS specifications summary

CPU	Intel® Socket 1151 for Intel® Core™ 9000 series, 8th Generation Core™ i7 / i5 / i3, Pentium®, and Celeron® processors Supports 14nm CPU Supports Intel® Turbo Boost Technology 2.0* * The Intel® Turbo Boost Technology 2.0 support depends on the CPU types. ** Refer to www.asus.com for Intel® CPU support list.
Chipset	Intel® Z390 Chipset
Memory	4 x DIMM, max. 64GB, DDR4 4133(O.C.)/ 4000(O.C.)/ 3866(O.C.)/ 3733(O.C.)/ 3600(O.C.)/ 3466(O.C.)/ 3400(O.C.)/ 3333(O.C.)/ 3300(O.C.)/ 3200(O.C.)/ 3000(O.C.)/ 2800(O.C.)/ 2666/ 2400/ 2133 MHz, non-ECC, un-buffered memory* Dual channel memory architecture Supports Intel® Extreme Memory Profile (XMP) * The maximum memory frequency supported varies by processor. ** Refer to www.asus.com for the latest Memory QVL (Qualified Vendors List).
Expansion slots	1 x PCIe 3.0/2.0 x16 slot (supports x16, x8+x4+x4*) 1 x PCIe 3.0/2.0 x16 slot (max. at x4 mode) 2 x PCIe 3.0/2.0 x1 slots * The PCIEX16_1 slot supports up to 3 Intel® PCIe NVMe SSDs via a Hyper M.2 X16 series Card.** ** The Hyper M.2 X16 series card is sold separately. Install a Hyper M.2 X16 series card and enable this card under BIOS settings.
Multi-GPU support	Supports AMD 2-Way/Quad-GPU CrossFireX™ Technology
VGA	Integrated Graphics Processor- Intel® UHD Graphics support Multi-VGA output support: HDMI/DVI ports - Supports HDMI 1.4b with max. resolution of 4096 x 2160 @30Hz - Supports DVI with max. resolution of 1920 x1200 @60Hz Supports Intel® InTru™ 3D/Quick Sync Video/Clear Video HD Technology/ Insider™

(continued on the next page)

PRIME Z390M-PLUS specifications summary

Storage	<p>Intel® CPU support with Intel® Rapid Storage Technology (RAID 0 & RAID 1)</p> <ul style="list-style-type: none"> - The PCIe X16_1 slot supports up to 3 Intel® PCIe NVMe SSDs via a Hyper M.2 X16 series Card.* <p>Intel® Z390 Chipset support with RAID 0, 1, 5, 10 and Intel® Rapid Storage Technology support</p> <ul style="list-style-type: none"> - 1 x M.2_1 Socket 3 with M Key, type 2242/2260/2280 storage devices support (PCIe x4 mode) - 1 x M.2_2 Socket 3 with M Key, type 2242/2260/2280/22110 storage devices support (both SATA & PCIe x4 mode) - 4 x SATA 6.0 Gb/s ports - Ready for Intel® Optane™ Memory <p>* The Hyper M.2 X16 series card is sold separately. Install a Hyper M.2 X16 series card and enable this card under BIOS settings.</p>
LAN	<p>Intel® I219-V Gigabit LAN</p> <p>Anti-surge LANGuard</p>
Audio	<p>Realtek® ALC887 8-channel* high definition audio CODEC</p> <ul style="list-style-type: none"> - LED-illuminated design: Brighten up your build with the gorgeous illuminated audio trace path. - Audio Shielding: Ensures precision analog/digital separation and greatly reduces multi-lateral interference. - Dedicated audio PCB layers: Separate layers for left and right channels to guard the quality of the sensitive audio signals. - Premium Japanese audio capacitors: Provide warm, natural and immersive sound with exceptional clarity and fidelity. - Supports jack-detection and front panel jack-retasking. <p>* Choose a chassis with HD audio module in front panel to support an 8-channel audio output.</p>
USB	<p>Intel® Z390 Chipset</p> <ul style="list-style-type: none"> - 2 x USB 3.1 Gen 2 ports up to 10Gbps at back panel - 8 x USB 3.1 Gen 1 ports up to 5Gbps (4 ports @mid-board; 4 ports @back panel) - 4 x USB 2.0 ports (4 ports @mid-board)
ASUS Special Features	<p>ASUS 5X PROTECTION III</p> <ul style="list-style-type: none"> - ASUS SafeSlot Core: Fortified PCIe Slot prevents damage - ASUS LANGuard: Protects against LAN surges, lightning strikes and static - electricity discharges - ASUS Overvoltage Protection: World-class circuit-protecting power design - ASUS Stainless-Steel Back I/O: 3x corrosion-resistance for greater durability - ASUS DIGI+ VRM

(continued on the next page)

ASUS PRIME Z390M-PLUS specifications summary

ASUS Special Features	Superb Performance
	OptiMem II - Improved DDR4 stability
	M.2 onboard - The latest transfer technologies with up to 32Gb/s data transfer speeds
	ASUS Fan Xpert 4 - Advanced fan and liquid controls for ultimate cooling and quietness
	ASUS EPU - EPU
	UEFI BIOS - The most advanced options with a fast response time
	ASUS Exclusive Features - MemOK! II - ASUS Ai Charger - ASUS AI Suite 3
	EZ DIY
	UEFI BIOS EZ Mode - Featuring friendly graphics user interface - ASUS CrashFree BIOS 3 - ASUS EZ Flash 3
	Q-Design - ASUS Q-Slot - ASUS Q-DIMM
ASUS Quiet Thermal Solution	- ASUS Fan Xpert 4 - Stylish Fanless Design: PCH Heat-sink & MOS Heat-sink
Back Panel I/O Ports	1 x DVI port 1 x HDMI port 1 x PS/2 mouse port (green) 1 x PS/2 keyboard port (purple) 1 x LAN (RJ45) port 2 x USB 3.1 Gen 2 ports (Type-A) 4 x USB 3.1 Gen 1 ports 3 x Audio jacks support 8-channel audio output* * Choose a chassis with HD audio module in front panel to support an 8-channel audio output.

(continued on the next page)

ASUS PRIME Z390M-PLUS specifications summary

Internal I/O Connectors	<p>2 x USB 3.1 Gen 1 connectors support additional 4 USB ports (19-pin) 2 x USB 2.0 connectors support additional 4 USB ports 1 x M.2_1 Socket 3 (for M Key, type 2242/2260/2280 devices) 1 x M.2_2 Socket 3 (for M Key, type 2242/2260/2280/22110 devices) 4 x SATA 6.0Gb/s connectors 1 x CPU Fan connector (support DC/PWM mode) 1 x AIO_Pump header (4-pin) 2 x Chassis Fan connectors (4-pin) for both 3-pin(DC mode) and 4-pin(PWM mode) coolers control 1 x Front panel audio connector (AAFP) 1 x 24-pin EATX Power connector 1 x 8-pin EATX 12V Power connector 1 x System panel connector* 1 x COM port 1 x S/PDIF header 1 x RGB header 1 x MemOK! II switch 1 x Clear CMOS jumper</p> <p>* The chassis intrusion header is built into the system panel connector.</p>
BIOS	<p>128 Mb Flash ROM, UEFI AMI BIOS, PnP, SM BIOS 3.1, ACPI 6.1, Multi-language BIOS, ASUS EZ Flash 3, CrashFree BIOS 3, F11 EZ Tuning Wizard, F6 Qfan Control, F3 My Favorites, Last Modified log, F9 Search, F12 PrintScreen, and ASUS DRAM SPD (Serial Presence Detect) memory information</p>
Manageability	<p>WfM 2.0, DMI 3.0, WOL by PME, PXE</p>
Support DVD	<p>Drivers ASUS Utilities ASUS EZ Update Anti-virus software (OEM version)</p>
OS Support	<p>Windows® 10 (64-bit)</p>
Form factor	<p>mATX form factor: 9.6 in. x 9.6 in. (24.4 cm x 24.4 cm)</p>



Specifications are subject to change without notice.

Product Introduction

1

1.1 Before you proceed

Take note of the following precautions before you install motherboard components or change any motherboard settings.



- Unplug the power cord from the wall socket before touching any component.
- Before handling components, use a grounded wrist strap or touch a safely grounded object or a metal object, such as the power supply case, to avoid damaging them due to static electricity.
- Before you install or remove any component, ensure that the ATX power supply is switched off or the power cord is detached from the power supply. Failure to do so may cause severe damage to the motherboard, peripherals, or components.

1.2 Motherboard overview

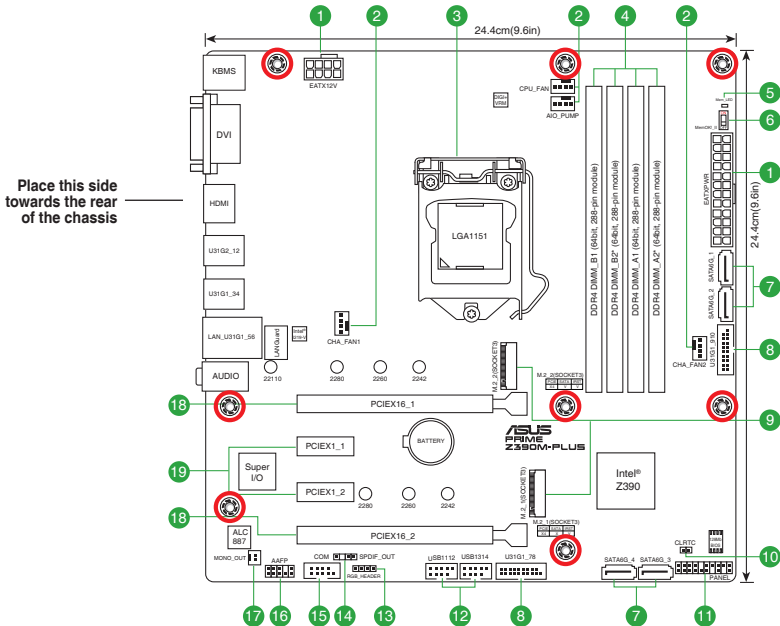

Unplug the power cord before installing or removing the motherboard. Failure to do so can cause you physical injury and damage motherboard components.

1.2.1 Layout contents

Connectors/Jumpers/Slots		Page
1.	ATX power connectors (24-pin EATXPWR, 8-pin EATX12V)	1-2
2.	CPU, chassis, and AIO pump fan connectors (4-pin CPU_FAN, 4-pin CHA_FAN1~2, 4-pin AIO_PUMP FAN)	1-3
3.	Intel® LGA1151 CPU socket	1-3
4.	DDR4 DIMM slots	1-3
5.	Memory LED (Mem_LED)	1-3
6.	MemOK! II switch	1-3
7.	Intel® Z390 Serial ATA 6.0 Gb/s connectors (7-pin SATA6G_1~4)	1-4
8.	USB 3.1 Gen 1 connectors (20-1 pin U31G1_78, U31G1_910)	1-4
9.	M.2 sockets (M.2_1; M.2_2)	1-5
10.	Clear RTC RAM (2-pin CLRRTC)	1-5
11.	System panel connector (20-3 pin PANEL)	1-5
12.	USB 2.0 connectors (10-1 pin USB1112, USB1314)	1-6
13.	AURA RGB header (4-pin RGB_HEADER)	1-6
14.	Digital audio connector (4-1 pin SPDIF_OUT)	1-6
15.	Serial port connector (10-1 pin COM)	1-6
16.	Front panel audio connector (10-1 pin AAFP)	1-6
17.	Mono out header (2-pin MONO_OUT)	1-7
18.	PCI Express 3.0/2.0 x16 slots	1-7
19.	PCI Express 3.0/2.0 x16 slots	1-7

1 ATX power connectors (24-pin EATXPWR, 8-pin EATX12V)

Correctly orient the ATX power supply plugs into these connectors and push down firmly until the connectors completely fit.

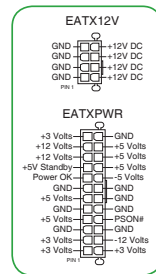

- For a fully configured system, we recommend that you use a power supply unit (PSU) that complies with ATX 12 V Specification 2.0 (or later version) and provides a minimum power of 350 W. This PSU type has 24-pin and 8-pin power plugs.
- We recommend that you use a PSU with higher power output when configuring a system with more power-consuming devices or when you intend to install additional devices. The system may become unstable or may not boot up if the power is inadequate.

2 Intel® LGA1151 CPU socket

Install Intel® LGA1151 CPU into this surface mount LGA1151 socket, which is designed for Intel® Core™ 9000 series, 8th Generation Core™ i7 / i5 / i3, Pentium®, and Celeron® processors.



For more details, refer to **1.3 Central Processing Unit (CPU)**.

3 CPU, chassis, and AIO pump fan connectors (4-pin CPU_FAN, 4-pin CHA_FAN1~2, 4-pin AIO_PUMP FAN)

Connect the fan cables to the fan connectors on the motherboard, ensuring that the black wire of each cable matches the ground pin of the connector.

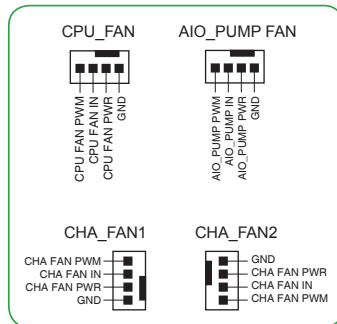

4 DDR4 DIMM slots

Install 2 GB, 4 GB, 8 GB, and 16 GB unbuffered non-ECC DDR4 DIMMs into these DIMM sockets.



For more details, refer to **1.4 System memory**.

5 Memory LED (Mem_LED)

The Mem_LED will light up and remain lit while the MemOK! II function is in use. When the re-training is complete, the Mem_LED will turn off.

6 MemOK! II switch (MemOK!_II)

Installing DIMMs that are not compatible with the motherboard may cause system boot failure. The switch is enabled by default, allowing memory re-training when the motherboard is unresponsive due to memory problems. The MEMOK_II_LED will light up while re-training, and turn off when the re-training is complete.



- The DRAM LED also lights up when the DIMM is not properly installed. Turn off the system and reinstall the DIMM before using the MemOK! II function.
- The MemOK! II switch does not function under Windows® OS environment.
- During the tuning process, the system loads and tests pretest profiles. It takes about 30 seconds for the system to test one set of profiles. If the test fails, the system reboots and tests the next set of profiles. The system will reboot multiple times when training, once the system has completed the training process the Mem_LED will turn off, please refrain from doing anything before the Mem_LED turns off.
- Due to memory tuning requirement, the system automatically reboots when each profile is tested.
- If you turn off the computer and replace DIMMs during the tuning process, the system continues memory tuning after turning on the computer. To stop memory tuning, turn off the computer and unplug the power cord for about 5–10 seconds, then set the MemOK! II switch to disabled.
- Ensure to replace the DIMMs with ones recommended in the Memory QVL (Qualified Vendors Lists) at www.asus.com.
- We recommend that you download and update to the latest BIOS version from www.asus.com after using the MemOK! II function.

7 Intel® Z390 Serial ATA 6.0 Gb/s connectors (7-pin SATA6G_1-4)

These connectors connect to Serial ATA 6.0 Gb/s hard disk drives via Serial ATA 6.0 Gb/s signal cables.

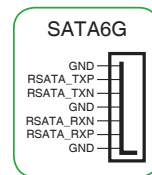

8 USB 3.1 Gen 1 connectors (20-1 pin U31G1_78, U31G1_910)

Connect a USB 3.1 Gen 1 module to any of these connectors for additional USB 3.1 Gen 1 front or rear panel ports. These connectors comply with USB 3.1 Gen 1 specifications and provides faster data transfer speeds of up to 5 Gbps, faster charging time for USB-chargeable devices, optimized power efficiency, and backward compatibility with USB 2.0

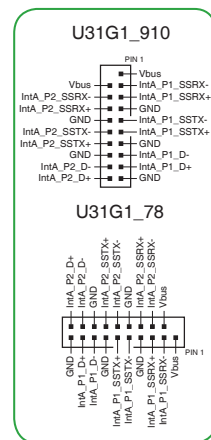

9

M.2 sockets (M.2_1; M.2_2)

These sockets allow you to install M.2 (NGFF) SSD modules.

M.2(SOCKET3)



- The M.2_1 socket supports M Key and 2242/2260/2280 storage devices (PCIe x4 mode), and supports data transfer speed of up to 32Gb/s.
- The M.2_2 socket supports M Key and 2242/2260/2280/22110 storage devices (both SATA & PCIe x4 mode), and supports data transfer speed of up to 32Gb/s.
- The M.2 SSD module is purchased separately.

10

Clear RTC RAM (2-pin CLRTC)

This header allows you to clear the CMOS RTC RAM data of the system setup information such as date, time, and system passwords.

To erase the RTC RAM:

1. Turn OFF the computer and unplug the power cord.
2. Use a metal object such as a screwdriver to short the two pins.
3. Plug the power cord and turn ON the computer.
4. Hold down the key during the boot process and enter BIOS setup to re-enter data.

CLRTC



If the steps above do not help, remove the onboard battery and short the two pins again to clear the CMOS RTC RAM data. After clearing the CMOS, reinstall the battery.

11

System panel connector (20-3 pin PANEL)

This connector supports several chassis-mounted functions.

- **System power LED (2-pin or 3-1 pin PLED)**

The 2-pin or 3-1 pin connector is for the system power LED.

- **Hard disk drive activity LED (2-pin HDD_LED)**

This 2-pin connector is for the HDD Activity LED.

- **System warning speaker (4-pin SPEAKER)**

This 4-pin connector is for the chassis-mounted system warning speaker.

PANEL

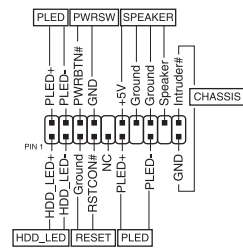

- **ATX power button/soft-off button (2-pin PWR_SW)**
This connector is for the system power button.
- **Reset button (2-pin RESET)**
This 2-pin connector is for the chassis-mounted reset button for system reboot without turning off the system power.
- **Chassis intrusion connector (2-pin CHASSIS)**
This connector is for a chassis-mounted intrusion detection sensor or switch.

12 USB 2.0 connectors (10-1 pin USB1112, USB1314)

Connect a USB module cable to any of these connectors, then install the module to a slot opening at the back of the system chassis. This USB connectors comply with USB 2.0 specifications and support up to 480Mbps connection speed.

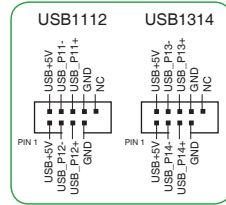

13 AURA RGB header (4-pin RGB_HEADER)

These connectors are for RGB LED strips.

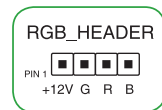

14 Digital audio connector (4-1 pin SPDIF_OUT)

This connector is for an additional Sony/Philips Digital Interface (S/PDIF) port. Connect the S/PDIF Out module cable to this connector, then install the module to a slot opening at the back of the system chassis.

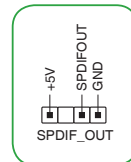

15 Serial port connector (10-1 pin COM)

This connector is for a serial (COM) port. Connect the serial port module cable to this connector, then install the module to a slot opening at the back of the system chassis.

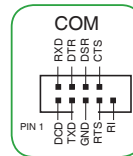

16 Front panel audio connector (10-1 pin AAFP)

This connector is for a chassis-mounted front panel audio I/O module that supports HD Audio standard. Connect one end of the front panel audio I/O module cable to this connector.

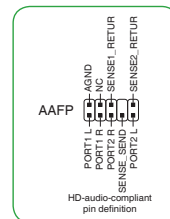

17 Mono out header (2-pin MONO_OUT)

This internal mono out header allows connection to an internal, low power speaker for basic system sound capability. The subsystem is capable of driving a speaker load of 4 Ohms at 2 Watts (rms).

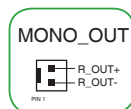

We recommend that you connect a high-definition front panel audio module to this connector to avail of the motherboard's high-definition audio capability.

18 PCI Express 3.0/2.0 x16 slots

This motherboard supports two PCI Express 3.0/2.0 x16 graphic cards that comply with the PCI Express specifications. Actual PCI Express speeds varies per BIOS settings.

VGA configuration	PCI Express operating mode	
	PCIe 3.0 x16_1 (gray)	PCIe 3.0 x16_2
Single VGA/PCIe card	x16 (Recommended for single VGA card)	N/A
Dual VGA/PCIe cards	x16	x4



- In single VGA card mode, use the PCIe 3.0 x16_1 slot (gray) for a PCI Express x16 graphics card to get better performance.
- We recommend that you provide sufficient power when running CrossFireX™ mode.
- Connect a chassis fan to the motherboard connector labeled CHA_FAN1/2 when using multiple graphics cards for better thermal environment.

19 PCI Express 3.0/2.0 x1 slots

This motherboard has two PCI Express 3.0/2.0 x1 slots that support PCI Express x1 network cards, SCSI cards, and other cards that comply with the PCI Express specifications.

1.2.2 Rear panel connectors

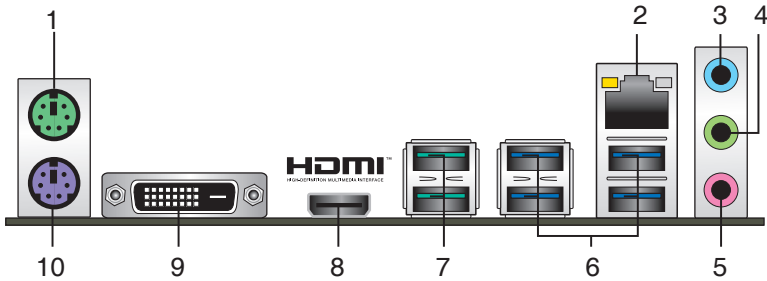

1. **PS/2 Mouse port (green).** This port connects to a PS/2 mouse.
2. **LAN (RJ-45) port.** This port allows Gigabit connection to a Local Area Network (LAN) through a network hub.

LAN port LED indications

Activity/Link LED		Speed LED	
Status	Description	Status	Description
Off	No link	OFF	10Mbps connection
Orange	Linked	ORANGE	100Mbps connection
Orange (Blinking)	Data activity	GREEN	1Gbps connection
Orange (Blinking then steady)	Ready to wake Wake up from S5 mode		

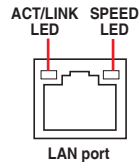

3. **Line In port (light blue).** This port connects to the tape, CD, DVD player, or other audio sources.
4. **Line Out port (lime).** This port connects to a headphone or a speaker. In the 4, 5.1 and 7.1-channel configurations, the function of this port becomes Front Speaker Out.
5. **Microphone port (pink).** This port connects to a microphone.



Refer to the audio configuration table for the function of the audio ports in 2, 4, 5.1, or 7.1-channel configuration.

Audio 2, 4, 5.1, or 7.1-channel configuration

Port	Headset 2-channel	4-channel	5.1-channel	7.1-channel
Light Blue (Rear panel)	Line In	Rear Speaker Out	Rear Speaker Out	Rear Speaker Out
Lime (Rear panel)	Line Out	Front Speaker Out	Front Speaker Out	Front Speaker Out
Pink (Rear panel)	Mic In	Mic In	Bass/Center	Bass/Center
Lime (Front panel)	-	-	-	Side Speaker Out



To configure a 7.1-channel audio output:

Use a chassis with HD audio module in the front panel to support a 7.1-channel audio output.

6. **USB 3.1 Gen 1 (up to 5Gbps) ports.** These 9-pin Universal Serial Bus (USB) ports connect to USB 3.1 Gen 1 devices.
7. **USB 3.1 Gen 2 (up to 10Gbps) Type-A ports.** These 9-pin Universal Serial Bus 3.1 (USB 3.1) ports are for USB 3.1 Gen 2 devices.



-
- USB 3.1 Gen 2 / Gen 1 devices can only be used for data storage.
 - Due to the design of the Intel® 300 series chipset, all USB devices connected to the USB 2.0 and USB 3.1 Gen 2 / Gen 1 ports are controlled by the xHCI controller. Some legacy USB devices must update their firmware for better compatibility.
 - We strongly recommend that you connect USB 3.1 Gen 2 devices to USB 3.1 Gen 2 ports for faster and better performance from your USB 3.1 Gen 2 devices.
-

8. **HDMI port.** This port is for a High-Definition Multimedia Interface (HDMI) connector, and is HDCP compliant allowing playback of HD DVD, Blu-ray, and other protected content.
9. **DVI-D port.** This port is for any DVI-D compatible device.



DVI-D can not be converted to output from RGB Signal to CRT and is not compatible with DVI-I.

10. **PS/2 Keyboard port (purple).** This port connects to a PS/2 keyboard.

1.3 Central Processing Unit (CPU)

This motherboard comes with a surface mount LGA1151 socket designed for the 8th Generation Intel® Core™ i7 / Core™ i5 / Core™ i3, Pentium® and Celeron® processors.

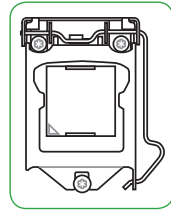

Unplug all power cables before installing the CPU.



- Ensure that you install the correct CPU designed for the LGA1151 socket only. DO NOT install a CPU designed for LGA1150, LGA1155 and LGA1156 sockets on the LGA1151 socket.
- Upon purchase of the motherboard, ensure that the PnP cap is on the socket and the socket contacts are not bent. Contact your retailer immediately if the PnP cap is missing, or if you see any damage to the PnP cap/socket contacts/motherboard components.
- Keep the cap after installing the motherboard. ASUS will process Return Merchandise Authorization (RMA) requests only if the motherboard comes with the cap on the LGA1151 socket.
- The product warranty does not cover damage to the socket contacts resulting from incorrect CPU installation/removal, or misplacement/loss/incorrect removal of the PnP cap.

Installing the CPU

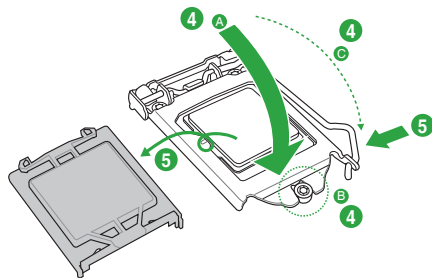
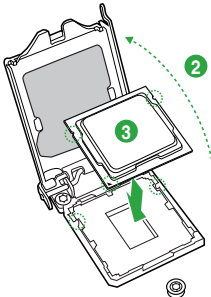
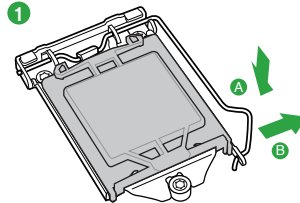
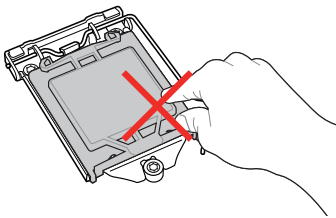

Apply the Thermal Interface Material to the CPU heatsink and CPU before you install the heatsink and fan if necessary.

1.4 System memory

Overview

This motherboard comes with four Double Data Rate 4 (DDR4) Dual Inline Memory Module (DIMM) sockets. The figure illustrates the location of the DDR4 DIMM sockets:

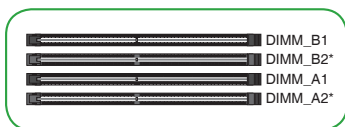

Channel	Sockets
Channel A	DIMM_A1 & DIMM_A2*
Channel B	DIMM_B1 & DIMM_B2*



- Always install DIMMs with the same CAS latency. For optimal compatibility, we recommend that you install memory modules of the same version or date code (D/C) from the same vendor. Check with the retailer to get the correct memory modules.
- According to Intel® CPU spec, DIMM voltage below 1.35V is recommended to protect the CPU.



- The default memory operation frequency is dependent on its Serial Presence Detect (SPD), which is the standard way of accessing information from a memory module. Under the default state, some memory modules for overclocking may operate at a lower frequency than the vendor-marked value.
- For system stability, use a more efficient memory cooling system to support a full memory load (4 DIMMs).
- Refer to www.asus.com for the latest Memory QVL (Qualified Vendors List)

Recommended memory configurations

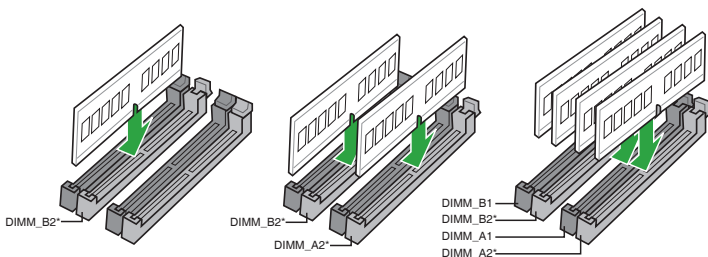

Installing a DIMM

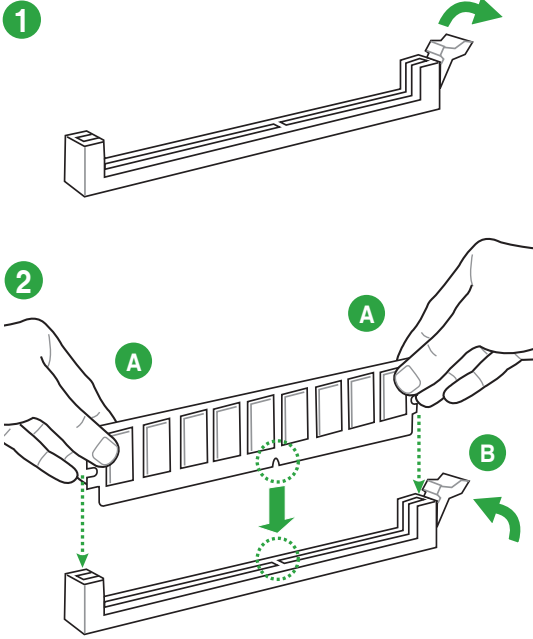

To remove a DIMM

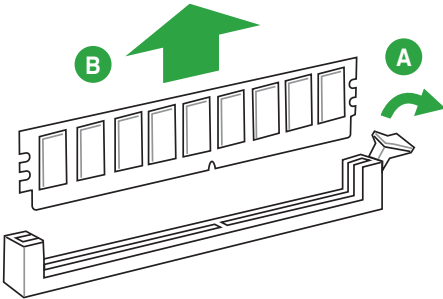

BIOS Information

2

2.1 Managing and updating your BIOS



Save a copy of the original motherboard BIOS file to a USB flash disk in case you need to restore the BIOS in the future. Copy the original motherboard BIOS using the ASUS Update utility.

2.1.1 EZ Update

EZ Update is a utility that allows you to automatically update your motherboard's softwares, drivers and the BIOS version easily. With this utility, you can also manually update the saved BIOS and select a boot logo when the system goes into POST.

To launch EZ Update, click **EZ Update** on the AI Suite 3 main menu bar.

The screenshot shows the ASUS EZ Update utility window. On the left, there is a text box with the instruction: "Click to automatically update your motherboard's driver, software and firmware". A red arrow points from this text to a blue "Check Now" button under the "Check updates from internet:" section. Below this, there is a section for manually updating BIOS logs or BIOS, with a text box and a file selection button "...". A red arrow points from the text "Click to find and select the BIOS from file" to this button. To the right of the file selection area, there are two buttons: "MyLogo" and "BIOS Update". A red arrow points from the text "Click to select a boot logo" to the "MyLogo" button, and another red arrow points from the text "Click to update the BIOS" to the "BIOS Update" button. The top right corner of the window displays "Current BIOS" information: Model Name: PRIME Z390M-PLUS, version: 300, Release Date: 09/06/2018.



EZ Update requires an Internet connection either through a network or an ISP (Internet Service Provider).

2.1.2 ASUS EZ Flash 3

The ASUS EZ Flash 3 feature allows you to update the BIOS without using an OS-based utility.



- Ensure that you load the BIOS default settings to ensure system compatibility and stability. Select the **Load Optimized Defaults** item under the Exit menu. See section **2.3 Exit Menu** for details.
- Check your Internet connection before updating the BIOS via the Internet.

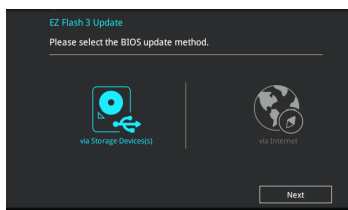

To update the BIOS using EZ Flash 3:

1. Enter the **Advanced Mode** of the BIOS setup program. Go to the **Tool** menu to select **ASUS EZ Flash 3 Utility** and press <Enter> to enable it.
2. Follow the steps below to update the BIOS via a storage device or Internet.

Via Storage Device

- a) Insert the USB flash disk that contains the latest BIOS file to the USB port, then select **via Storage Device**.
- b) Press <Tab> to switch to the **Drive** field.
- c) Press the Up/Down arrow keys to find the USB flash disk that contains the latest BIOS, and then press <Enter>.
- d) Press <Tab> to switch to the **Folder Info** field.
- e) Press the Up/Down arrow keys to find the BIOS file, and then press <Enter> to perform the BIOS update process.

Via Internet

- a) Select **via Internet**.
 - b) Press the Left/Right arrow keys to select an Internet connection method, and then press <Enter>.
 - c) Follow the onscreen instructions to complete the update.
3. Reboot the system when the update process is done.



- ASUS EZ Flash 3 supports USB devices, such as a USB flash disk, with FAT 32/16 format and single partition only.
- DO NOT shut down or reset the system while updating the BIOS to prevent system boot failure!

2.1.3 ASUS CrashFree BIOS 3 utility

The ASUS CrashFree BIOS 3 is an auto recovery tool that allows you to restore the BIOS file when it fails or gets corrupted during the updating process. You can restore a corrupted BIOS file using the motherboard support DVD or a USB flash drive that contains the updated BIOS file.



- Before using this utility, rename the BIOS file in the removable device into **PZ390MP.CAP**.
- The BIOS file in the support DVD may not be the latest version. Download the latest BIOS file from the ASUS website at www.asus.com.

Recovering the BIOS

To recover the BIOS:

1. Turn on the system.
2. Insert the support DVD to the optical drive or the USB flash drive that contains the BIOS file to the USB port.
3. The utility automatically checks the devices for the BIOS file. When found, the utility reads the BIOS file and enters ASUS EZ Flash 3 utility automatically.
4. The system requires you to enter BIOS Setup to recover BIOS settings. To ensure system compatibility and stability, we recommend that you press <F5> to load default BIOS values.



DO NOT shut down or reset the system while updating the BIOS! Doing so can cause system boot failure!

2.1.4 ASUS BIOS Updater

ASUS BIOS Updater allows you to update the BIOS in DOS environment.



The screen captures used in this section are for reference only and may not be exactly the same as actually shown on your computer screen.

Before updating BIOS

- Prepare the motherboard support DVD and a USB flash drive.
- Download the latest BIOS file and BIOS Updater from <http://support.asus.com> and save them in your USB flash drive.



NTFS is not supported under FreeDOS environment. Ensure that your USB flash drive is in single partition and in FAT32/16 format.

- Turn off the computer.
- Ensure that your computer has a DVD optical drive.



NTFS is not supported under FreeDOS environment. Ensure that your USB flash drive is in single partition and in FAT32/16 format.

- Turn off the computer.
- Ensure that your computer has a DVD optical drive.

Booting the system in DOS environment

To boot the system in DOS:

1. Insert the USB flash drive with the latest BIOS file and BIOS Updater to the USB port.
2. Boot your computer then press <F8> to launch the select boot device screen.
3. When the select boot device screen appears, insert the Support DVD into the optical drive then select the optical drive as the boot device.

Please select boot device:

↑ and ↓ to move selection
ENTER to select boot device
ESC to boot using defaults

```
P2: ST3808110AS (76319MB)
aigo miniking (250MB)
UEFI: (FAT) ASUS DRW-2014L1T(4458MB)
P1: ASUS DRW-2014L1T(4458MB)
UEFI: (FAT) aigo miniking (250MB)
Enter Setup
```

4. When the booting message appears, press <Enter> within five (5) seconds to enter FreeDOS prompt.

```
ISOLINUX 3.20 2006-08-26 Copyright (C) 1994-2005 H. Peter Anvin
A Bootable DVD/CD is detected. Press ENTER to boot from the DVD/CD.
If no key is pressed within 5 seconds, the system will boot next priority
device automatically. boot:
```

5. On the FreeDOS prompt, type **d:** then press <Enter> to switch the disk from Drive C (optical drive) to Drive D (USB flash drive).

```
Welcome to FreeDOS (http://www.freedos.org) !
C: /> d:
D: />
```

Updating the BIOS file

To update the BIOS file:

1. On the FreeDOS prompt, type **bupdater /g** and press <Enter>.

```
D: /> bupdater /g
```

- On the BIOS Updater screen, press <Tab> to switch from Files panel to Drives panel then select **D:**.

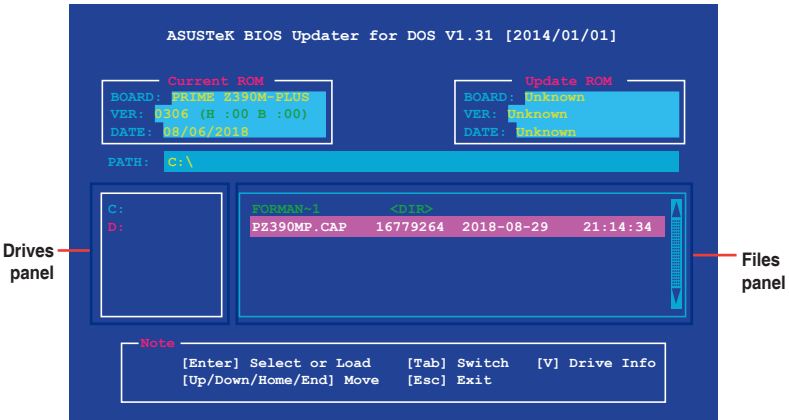

- Press <Tab> to switch from Drives panel to Files panel then press <Up/Down or Home/End> keys to select the BIOS file and press <Enter>.
- After the BIOS Updater checks the selected BIOS file, select **Yes** to confirm the BIOS update.



The BIOS Backup feature is not supported due to security regulations.

- Select **Yes** then press <Enter>. When BIOS update is done, press <ESC> to exit BIOS Updater.
- Restart your computer.



DO NOT shut down or reset the system while updating the BIOS to prevent system boot failure.



Ensure to load the BIOS default settings to ensure system compatibility and stability. Select the **Load Optimized Defaults** item under the **Exit BIOS** menu. See section 2.3 **Exit Menu** for details.

2.2 BIOS setup program

Use the BIOS Setup program to update the BIOS or configure its parameters. The BIOS screens include navigation keys and brief online help to guide you in using the BIOS Setup program.

Entering BIOS Setup at startup

To enter BIOS Setup at startup:

Press <Delete> or <F2> during the Power-On Self Test (POST). If you do not press <Delete> or <F2>, POST continues with its routines.

Entering BIOS Setup after POST

To enter BIOS Setup after POST:

Press <Ctrl>+<Alt>+ simultaneously.

Press the reset button on the system chassis.

Press the power button to turn the system off then back on. Do this option only if you failed to enter BIOS Setup using the first two options.



Using the power button, reset button, or the <Ctrl>+<Alt>+ keys to force reset from a running operating system can cause damage to your data or system. We recommend you always shut down the system properly from the operating system.



- The BIOS setup screens shown in this section are for reference purposes only, and may not exactly match what you see on your screen.
 - Visit the ASUS website at www.asus.com to download the latest BIOS file for this motherboard.
 - Ensure that a USB mouse is connected to your motherboard if you want to use the mouse to control the BIOS setup program.
 - If the system becomes unstable after changing any BIOS setting, load the default settings to ensure system compatibility and stability. Select the **Load Optimized Defaults** item under the Exit menu or press hotkey F5. See section 2.3 **Exit Menu** for details.
 - If the system fails to boot after changing any BIOS setting, try to clear the CMOS and reset the motherboard to the default value. See section 1.2 **Motherboard overview** for information on how to erase the RTC RAM.
-

BIOS menu screen

The BIOS setup program can be used under two modes: **EZ Mode** and **Advanced Mode**. Press <F7> to change between the two modes.

2.2.1 EZ Mode

By default, the EZ Mode screen appears when you enter the BIOS setup program. The EZ Mode provides you an overview of the basic system information, and allows you to select the display language, system performance mode, fan profile and boot device priority. To access the Advanced Mode, click **Advanced Mode(F7)** or press <F7>.



The default screen for entering the BIOS setup program can be changed. Go to the **Setup Mode** item in the **Boot** menu.

The screenshot shows the ASUS UEFI BIOS Utility - EZ Mode interface. The interface is divided into several sections:

- Information:** Displays system status including date (08/03/2018), time (16:45), language (English), and system details like PRIME Z390M-PLUS BIOS Ver. 0238, CPU (Intel(R) CPU 0000 @ 3.10GHz), Speed (3100 MHz), and Memory (8192 MB (DDR4 2133MHz)).
- CPU Temperature:** Shows CPU Core Voltage (0.977 V) and Motherboard Temperature (26°C).
- DRAM Status:** Lists DIMM slots (A1, A2, B1, B2) and their status (N/A).
- Storage Information:** Shows USB storage (35YSEM USB Flash Disk 1.00 (8.0GB)).
- Intel Rapid Storage Technology:** Includes a graph for CPU FAN speed and a QFan Control button.
- EZ System Tuning:** Allows selecting a pre-configured profile for improved system performance or energy savings.
- Boot Priority:** Lists boot devices (UEFI: 35YSEM USB Flash Disk 1.00 (8.0GB)) and a Switch all button.
- FAN Profile:** Shows CPU FAN (2122 RPM) and CHA2 FAN (N/A).
- X.M.P.:** Shows Disabled status.
- Navigation:** Includes buttons for Default(F5), Save & Exit(F10), Advanced Mode(F7) | →, and Search on FAQ.

Annotations and callouts:

- Displays a quick overview of the system status (points to Information section)
- Creates storage RAID and configures system overlocking (points to Storage Information)
- Selects the display language of the BIOS setup program (points to English)
- Displays the system properties of the selected mode. Click < or > to switch EZ System Tuning modes (points to EZ System Tuning)
- Search(F9) (points to Search(F9) button)
- Enables or disables the SATA RAID mode for Intel Rapid Storage Technology (points to Intel Rapid Storage Technology)
- Displays the CPU Fan's speed. Click the button to manually tune the fans (points to CPU FAN graph)
- Loads optimized default settings (points to QFan Control button)
- Saves the changes and resets the system (points to Save & Exit(F10) button)
- Click to go to Advanced mode (points to Advanced Mode(F7) | → button)
- Search on the FAQ (points to Search on FAQ button)
- Click to display boot devices (points to Boot Priority section)
- Selects the boot device priority (points to Switch all button)



The boot device options vary depending on the devices you installed to the system.

2.2.2 Advanced Mode

The Advanced Mode provides advanced options for experienced end-users to configure the BIOS settings. The figure below shows an example of the **Advanced Mode**. Refer to the following sections for the detailed configurations.



To access the EZ Mode, click **EzMode(F7)** or press <F7>.

The screenshot shows the ASUS UEFI BIOS Utility in Advanced Mode. The interface is dark-themed with blue accents. At the top, there is a search bar (F9) and a menu bar with options: My Favorites, Main, AI Tweaker, Advanced, Monitor, Boot, Tool, and Exit. The AI Tweaker section is expanded, showing various configuration fields such as 3-Core Ratio Limit, 4-Core Ratio Limit, 5-Core Ratio Limit, 6-Core Ratio Limit, DRAM Odd Ratio Mode, DRAM Frequency, OC Tuner, and Power-saving & Performance Mode. A pop-up menu is visible for the Power-saving & Performance Mode, with options: Auto, Max Power-Saving Mode, and Performance mode. On the right side, there is a Hardware Monitor section displaying CPU and Memory status, and a Voltage section showing various voltage levels. At the bottom, there is a footer with version information, copyright, and navigation options like EzMode(F7) and Hot Keys.

Labels in the image point to the following components:

- Menu items
- Menu bar
- Language
- MyFavorite(F3)
- Qfan Control(F6)
- EZ Tuning Wizard(F11)
- Search(F9)
- Scroll bar
- Hardware Monitor
- Submenu items
- General help
- Configuration fields
- Pop-up Menu
- Last modified settings
- Go back to EZ Mode
- Search on the FAQ
- Displays a quick overview of the system status

Menu bar

The menu bar on top of the screen has the following main items:

My Favorites	For saving the frequently-used system settings and configuration
Main	For changing the basic system configuration
Ai Tweaker	For changing the overclocking settings
Advanced	For changing the advanced system settings
Monitor	For displaying the system temperature, power status, and changing the fan settings
Boot	For changing the system boot configuration
Tool	For configuring options for special functions
Exit	For selecting the exit options and loading default settings

Menu items

The highlighted item on the menu bar displays the specific items for that menu. For example, selecting **Main** shows the Main menu items.

The other items (My Favorites, Ai Tweaker, Advanced, Monitor, Boot, Tool, and Exit) on the menu bar have their respective menu items.

Submenu items

A greater than sign (>) before each item on any menu screen means that the item has a submenu. To display the submenu, select the item and press <Enter>.

Language

This button above the menu bar contains the languages that you can select for your BIOS. Click this button to select the language that you want to display in your BIOS screen.

My Favorites (F3)

This button above the menu bar shows all BIOS items in a Tree Map setup. Select frequently-used BIOS settings and save it to MyFavorites menu.

Q-Fan Control (F6)

This button above the menu bar displays the current settings of your fans. Use this button to manually tweak the fans to your desired settings.

EZ Tuning Wizard(F11)

This button above the menu bar allows you to view and tweak the overclocking settings of your system. It also allows you to change the motherboard's SATA mode from AHCI to RAID mode.

Search (F9)

This button allows you to search for BIOS items by entering its name, enter the item name to find the related item listing.

Search on FAQ

Move your mouse over this button to show a QR code, scan this QR code on your mobile device to connect to the BIOS FAQ web page of the ASUS support website. You can also scan the following QR code:



Scroll bar

A scroll bar appears on the right side of a menu screen when there are items that do not fit on the screen. Press the Up/Down arrow keys or <Page Up> / <Page Down> keys to display the other items on the screen.

General help

At the bottom of the menu screen is a brief description of the selected item. Use <F12> key to capture the BIOS screen and save it to the removable storage device.

Configuration fields

These fields show the values for the menu items. If an item is user-configurable, you can change the value of the field opposite the item. You cannot select an item that is not user-configurable.

A configurable field is highlighted when selected. To change the value of a field, select it and press <Enter> to display a list of options.

Hot keys

This button contains the navigation keys for the BIOS setup program. Use the navigation keys to select items in the menu and change the settings.

Last Modified button

This button shows the items that you last modified and saved in BIOS Setup.

2.3 Exit menu

The Exit menu items allow you to load the optimal default values for the BIOS items, and save or discard your changes to the BIOS items.

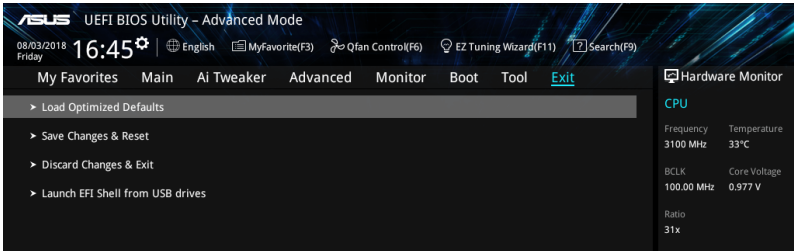

Load Optimized Defaults

This option allows you to load the default values for each of the parameters on the Setup menus. When you select this option or if you press <F5>, a confirmation window appears. Select OK to load the default values.

Save Changes & Reset

Once you are finished making your selections, choose this option from the Exit menu to ensure the values you selected are saved. When you select this option or if you press <F10>, a confirmation window appears. Select OK to save changes and exit.

Discard Changes & Exit

This option allows you to exit the Setup program without saving your changes. When you select this option or if you press <Esc>, a confirmation window appears. Select OK to discard changes and exit.

Launch EFI Shell from USB drives

This option allows you to attempt to launch the EFI Shell application (shellx64.efi) from one of the available USB devices.

Notices

FCC Compliance Information

Responsible Party: Asus Computer International

Address: 48720 Kato Rd., Fremont, CA 94538, USA

Phone / Fax No: (510)739-3777 / (510)608-4555

This device complies with part 15 of the FCC Rules. Operation is subject to the following two conditions: (1) This device may not cause harmful interference, and (2) this device must accept any interference received, including interference that may cause undesired operation.

This equipment has been tested and found to comply with the limits for a Class B digital device, pursuant to part 15 of the FCC Rules. These limits are designed to provide reasonable protection against harmful interference in a residential installation. This equipment generates, uses and can radiate radio frequency energy and, if not installed and used in accordance with the instructions, may cause harmful interference to radio communications. However, there is no guarantee that interference will not occur in a particular installation. If this equipment does cause harmful interference to radio or television reception, which can be determined by turning the equipment off and on, the user is encouraged to try to correct the interference by one or more of the following measures:

- Reorient or relocate the receiving antenna.
- Increase the separation between the equipment and receiver.
- Connect the equipment into an outlet on a circuit different from that to which the receiver is connected.
- Consult the dealer or an experienced radio/TV technician for help.

Compliance Statement of Innovation, Science and Economic Development Canada (ISED)

This device complies with Innovation, Science and Economic Development Canada licence exempt RSS standard(s). Operation is subject to the following two conditions: (1) this device may not cause interference, and (2) this device must accept any interference, including interference that may cause undesired operation of the device.

CAN ICES-3(B)/NMB-3(B)

Déclaration de conformité de Innovation, Sciences et Développement économique Canada (ISED)

Le présent appareil est conforme aux CNR d'Innovation, Sciences et Développement économique Canada applicables aux appareils radio exempts de licence. L'exploitation est autorisée aux deux conditions suivantes : (1) l'appareil ne doit pas produire de brouillage, et (2) l'utilisateur de l'appareil doit accepter tout brouillage radioélectrique subi, même si le brouillage est susceptible d'en compromettre le fonctionnement.

CAN ICES-3(B)/NMB-3(B)

VCCI: Japan Compliance Statement

Class B ITE

この装置は、クラスB情報技術装置です。この装置は、家庭環境で使用することを目的としています。この装置がラジオやテレビジョン受信機に近接して使用されると、受信障害を引き起こすことがあります。

取扱説明書に従って正しい取り扱いをして下さい。

VCCI-B

KC: Korea Warning Statement

B급 기기 (가정용 방송통신기자재)

이 기기는 가정용(B급) 전자파적합기기로서 주로 가정에서 사용하는 것을 목적으로 하며, 모든 지역에서 사용할 수 있습니다.

REACH

Complying with the REACH (Registration, Evaluation, Authorisation, and Restriction of Chemicals) regulatory framework, we published the chemical substances in our products at ASUS REACH website at <http://csr.asus.com/english/REACH.htm>.



DO NOT throw the motherboard in municipal waste. This product has been designed to enable proper reuse of parts and recycling. This symbol of the crossed out wheeled bin indicates that the product (electrical and electronic equipment) should not be placed in municipal waste. Check local regulations for disposal of electronic products.



DO NOT throw the mercury-containing button cell battery in municipal waste. This symbol of the crossed out wheeled bin indicates that the battery should not be placed in municipal waste.

ASUS Recycling/Takeback Services

ASUS recycling and takeback programs come from our commitment to the highest standards for protecting our environment. We believe in providing solutions for you to be able to responsibly recycle our products, batteries, other components as well as the packaging materials. Please go to <http://csr.asus.com/english/Takeback.htm> for detailed recycling information in different regions.

Regional notice for California



WARNING

Cancer and Reproductive Harm -
www.P65Warnings.ca.gov

Google™ License Terms

Copyright© 2018 Google Inc. All Rights Reserved.

Licensed under the Apache License, Version 2.0 (the "License"); you may not use this file except in compliance with the License. You may obtain a copy of the License at:

<http://www.apache.org/licenses/LICENSE-2.0>

Unless required by applicable law or agreed to in writing, software distributed under the License is distributed on an "AS IS" BASIS, WITHOUT WARRANTIES OR CONDITIONS OF ANY KIND, either express or implied.

See the License for the specific language governing permissions and limitations under the License.

English ASUSTeK Computer Inc. hereby declares that this device is in compliance with the essential requirements and other relevant provisions of related Directives. Full text of EU declaration of conformity is available at: www.asus.com/support

Français AsusTek Computer Inc. déclare par la présente que cet appareil est conforme aux critères essentiels et autres clauses pertinentes des directives concernées. La déclaration de conformité de l'UE peut être téléchargée à partir du site Internet suivant: www.asus.com/support

Deutsch ASUSTeK Computer Inc. erklärt hiermit, dass dieses Gerät mit den wesentlichen Anforderungen und anderen relevanten Bestimmungen der zugehörigen Richtlinien übereinstimmt. Der gesamte Text der EU-Konformitätserklärung ist verfügbar unter: www.asus.com/support

Italiano ASUSTeK Computer Inc. con la presente dichiara che questo dispositivo è conforme ai requisiti essenziali e alle altre disposizioni pertinenti con le direttive correlate. Il testo completo della dichiarazione di conformità UE è disponibile all'indirizzo: www.asus.com/support

Русский Компания ASUS заявляет, что это устройство соответствует основным требованиям и другим соответствующим условиям соответствующих директив. Подробную информацию, пожалуйста, смотрите на www.asus.com/support

Български С настоящото ASUSTeK Computer Inc. декларира, че това устройство е в съответствие със съществените изисквания и другите приложими постановления на свързаните директиви. Пълният текст на декларацията за съответствие на ЕС е достъпен на адрес: www.asus.com/support

Hrvatski ASUSTeK Computer Inc. ovim izjavljuje da je ovaj uređaj sukladan s bitnim zahtjevima i ostalim odgovarajućim odredbama vezanih direktiva. Cijeli tekst EU izjave o skladnosti dostupan je na: www.asus.com/support

Čeština Společnost ASUSTeK Computer Inc. tímto prohlašuje, že toto zařízení splňuje základní požadavky a další příslušná ustanovení souvisejících směrnic. Plné znění prohlášení o shodě EU je k dispozici na adrese: www.asus.com/support

Dansk ASUSTeK Computer Inc. erklærer hermed, at denne enhed er i overensstemmelse med hovedkravene og andre relevante bestemmelser i de relaterede direktiver. Hele EU-overensstemmelseserklæringen kan findes på: www.asus.com/support

Nederlands ASUSTeK Computer Inc. verklaart hierbij dat dit apparaat voldoet aan de essentiële vereisten en andere relevante bepalingen van de verwante richtlijnen. De volledige tekst van de EU-verklaring van conformiteit is beschikbaar op: www.asus.com/support

Eesti Käesolevaga kinnitab ASUSTeK Computer Inc, et see seade vastab asjakohaste direktiivide olulistele nõuetele ja teistele asjassepuutuvatele sätetele. El vastavusdeklaratsiooni täielik tekst on saadaval järgmisel aadressil: www.asus.com/support

Suomi ASUSTeK Computer Inc. ilmoittaa täten, että tämä laite on asiaankuuluvien direktiivien olennaisten vaatimusten ja muiden tätä koskevien säädösten mukainen. EU-yhdenmukaisuusilmoituksen koko teksti on luettavissa osoitteessa: www.asus.com/support

Ελληνικά Με το παρόν, η ASUSTeK Computer Inc. δηλώνει ότι αυτή η συσκευή συμμορφώνεται με τις θεμελιώδεις απαιτήσεις και άλλες σχετικές διατάξεις των Οδηγιών της ΕΕ. Το πλήρες κείμενο της δήλωσης συμμόρφωσης είναι διαθέσιμο στη διεύθυνση: www.asus.com/support

Magyar Az ASUSTeK Computer Inc. ezennel kijelenti, hogy ez az eszköz megfelel a kapcsolódó irányelvek lényeges követelményeinek és egyéb vonatkozó rendelkezéseinek. Az EU megfélelősegi nyilatkozat teljes szövege innen letölthető: www.asus.com/support

Latviski ASUSTeK Computer Inc. ar šo paziņo, ka šī ierīce atbilst saistošo Direktīvu būtiskajām prasībām un citiem citiem saistošajiem nosacījumiem. Pilns ES atbilstības paziņojuma teksts pieejams šeit: www.asus.com/support

Lietuvių „ASUSTeK Computer Inc.“ šiuo tvirtina, kad šis įrenginys atitinka pagrindinius reikalavimus ir kitas svarbias susijusių direktyvų nuostatas. Visą ES atitikties deklaracijos tekstą galima rasti: www.asus.com/support

Norsk ASUSTeK Computer Inc. erklærer herved at denne enheten er i samsvar med hovedsaklige krav og andre relevante forskrifter i relaterte direktiver. Fullstendig tekst for EU-samsvarserklæringen finnes på: www.asus.com/support

Polski Firma ASUSTeK Computer Inc. niniejszym oświadcza, że urządzenie to jest zgodne z zasadniczymi wymogami i innymi właściwymi postanowieniami powiązanych dyrektyw. Pełny tekst deklaracji zgodności UE jest dostępny pod adresem: www.asus.com/support

Português A ASUSTeK Computer Inc. declara que este dispositivo está em conformidade com os requisitos essenciais e outras disposições relevantes das Diretivas relacionadas. Texto integral da declaração da UE disponível em: www.asus.com/support

Română ASUSTeK Computer Inc. declară că acest dispozitiv se conformează cerințelor esențiale și altor prevederi relevante ale directivelor conexe. Textul complet al declarației de conformitate a Uniunii Europene se găsește la: www.asus.com/support

Srpski ASUSTeK Computer Inc. ovim izjavljuje da je ovaj uređaj u saglasnosti sa osnovnim zahtevima i drugim relevantnim odredbama povezanih Direktiva. Pun tekst EU deklaracije o usaglasenosti je dostupan da adres: www.asus.com/support

Slovensky Spoločnosť ASUSTeK Computer Inc. týmto vyhlasuje, že toto zariadenie vyhovuje základným požiadavkám a ostatým príslušným ustanoveniam príslušných smerníc. Celý text vyhlásenia je zobrazený na adrese: www.asus.com/support

Slovenščina ASUSTeK Computer Inc. izjavlja, da je ta naprava skladna z bistvenimi zahtevami in drugimi ustreznimi določbami povezanih direktiv. Celotno besedilo EU-izjave o skladnosti je na voljo na spletnem mestu: www.asus.com/support

Español Por la presente, ASUSTeK Computer Inc. declara que este dispositivo cumple los requisitos básicos y otras disposiciones pertinentes de las directivas relacionadas. El texto completo de la declaración de la UE de conformidad está disponible en: www.asus.com/support

Svenska ASUSTeK Computer Inc. förklarar härmed att denna enhet överensstämmer med de grundläggande kraven och andra relevanta föreskrifter i relaterade direktiv. Fulltext av EU-försäkran om överensstämmelse finns på: www.asus.com/support

Українська ASUSTeK Computer Inc. заявляє, що цей пристрій відповідає основним вимогам та іншим відповідним положенням відповідних Директив. Повний текст декларації відповідності стандартам ЄС доступний на: www.asus.com/support

Türkçe ASUSTeK Computer Inc., bu aygıtın temel gereksinimlerle ve ilişkili Yönergelerin diğer ilgili kullarıyla uyumlu olduğunu beyan eder. AB uygunluk bildirimini tam metni şu adreste bulunabilir: www.asus.com/support

Bosanski ASUSTeK Computer Inc. ovim izjavljuje da je ovaj uređaj uskladen sa bitnim zahtjevima i ostalim odgovarajućim odredbama vezanih direktiva. Cijeli tekst EU izjave o uskladenosti dostupan je na: www.asus.com/support

ASUS contact information

ASUSTeK COMPUTER INC.

Address 4F, No. 150, Li-Te Road, Peitou, Taipei 112, Taiwan
Telephone +886-2-2894-3447
Fax +886-2-2890-7798
Web site www.asus.com

Technical Support

Telephone +86-21-38429911
Fax +86-21-5866-8722, ext. 9101#
Online support <http://qr.asus.com/techserv>

ASUS COMPUTER INTERNATIONAL (America)

Address 48720 Kato Rd., Fremont, CA 94538, USA
Telephone +1-510-739-3777
Fax +1-510-608-4555
Web site <http://www.asus.com/us/>

Technical Support

Support fax +1-812-284-0883
Telephone +1-812-282-2787
Online support <http://qr.asus.com/techserv>

ASUS COMPUTER GmbH (Germany and Austria)

Address Harkort Str. 21-23, 40880 Ratingen, Germany
Fax +49-2102-959931
Web site <http://www.asus.com/de>
Online contact <http://eu-rma.asus.com/sales>

Technical Support

Telephone +49-2102-5789555
Support Fax +49-2102-959911
Online support <http://qr.asus.com/techserv>

Lined writing area with 27 horizontal lines.